

CEC UM1-612L-3

SECTION BB

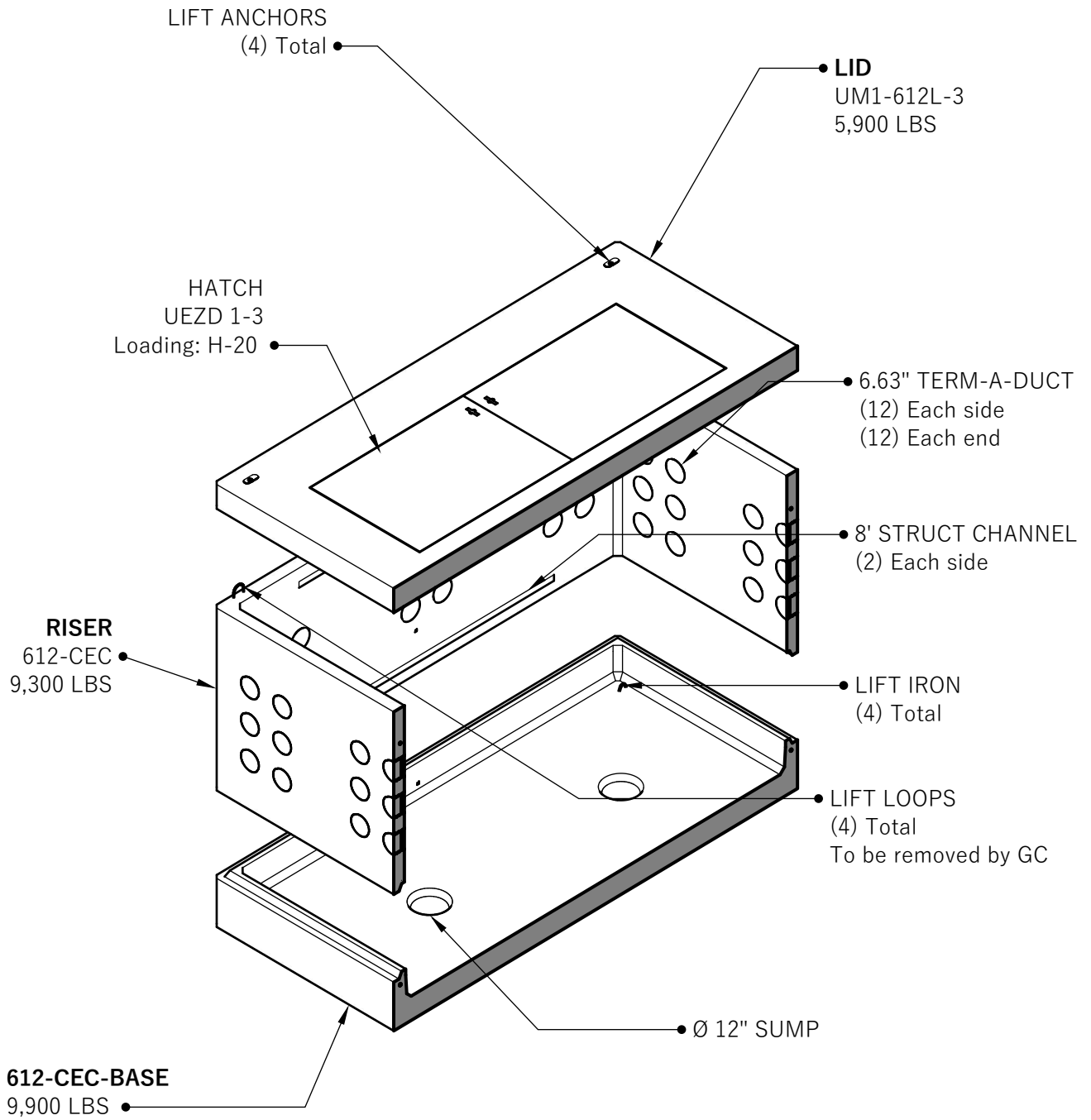

Customer:
Project:
Product: CEC UM1-612L-3



CEC UM1-612L-3

541-923-3272
1111 NE 11TH ST.
REDMOND, OR
97756

CEC UM1-612L-3

PLAN VIEW

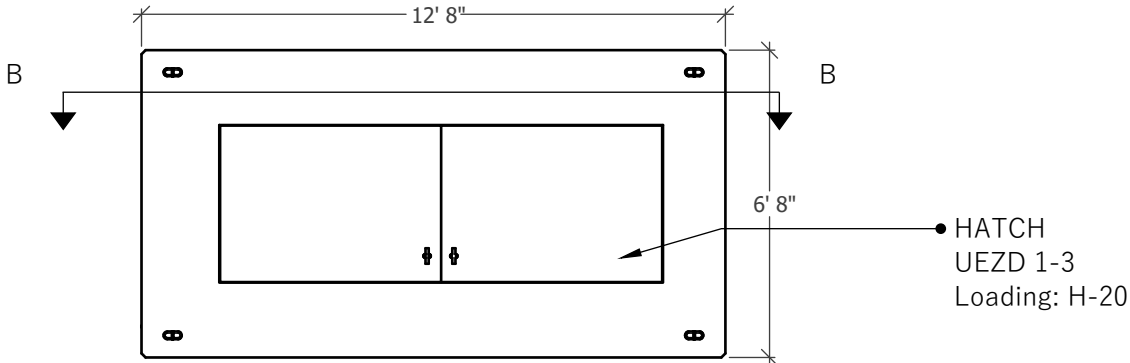

SIDE VIEW

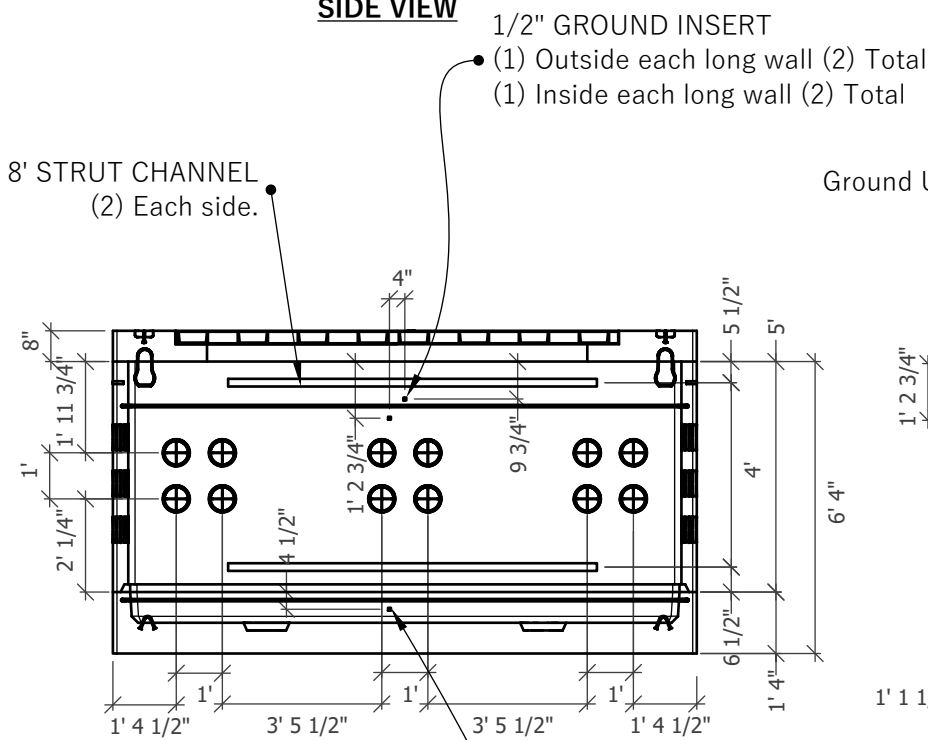

END VIEW

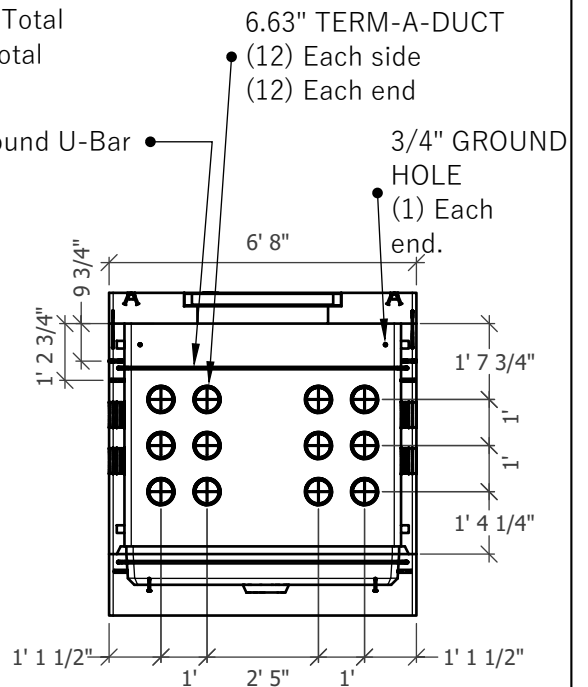

1/2" GROUND INSERT
 (1) Inside each long wall
 (2) Total

Customer:

Project:

Product: CEC UM1-612L-3



CEC UM1-612L-3

541-923-3272
 1111 NE 11TH ST.
 REDMOND, OR
 97756